

A large, light gray world map is centered in the background, composed of a grid of dots of varying density to create the shape of continents. The map is centered behind the main title.

Fire Alarm System

The Intelligent Solution

Leading global technology
Safe guarding lives and properties



GST200N

Intelligent Fire Alarm Control Panel

Overview

GST200N Intelligent Fire Alarm Control Panel includes GST200N-1, and GST200N-2. GST200N-1 is single loop panel, possible to be expanded the 2-loop version GST200N-2. They are suitable for small buildings like office, restaurant, store, shop, etc., provide simple installation, operation, and easy maintenance.

Features

- Wide range power supply, 100-240VAC, 50-60Hz
- Max. 30 zones. Each zone has its own alarm and fault/disable indicator and a label
- Capacity 235 addressable devices
- Optional expanded to 2 loops, 477 loop devices
- Compatible with GST intelligent and digital products
- 8X18 characters LCD screen
- Non-Volatile memory ensures the data does not loss even if power supply is accidentally removed

LC200

Loop Card For additional 2nd loop



P-9940A

RS485 Class A Network Card



P-9930

RS232 card for PC connection



P-9960

CAN Class B Network Card



P-9930ModBus

ModBus Card for 3rd party interfacing



P-9960A

CAN Class A Network Card



P-9930TCPIP

TCP/IP Network Card



P-9905

USB Printer Interface



P-9901A

Panel Printer





GST-IFP8

Intelligent Fire Alarm Control Panel

Overview

GST-IFP8 Intelligent Fire Alarm Control Panel is modularized multi-loop model, can be expanded to 8 loops (Max. 10 loops without network function). The panel is suitable for small to medium projects.

Features

- Max.999 zones, 140 have individual alarm and fault/disable LEDs and a label
- 8 Class A loops, total capacity of 1936 devices
- 15X40 LCD screen, assisting the 17 LEDs to display important information
- Compatible with full series of GST addressable and digital products
- Non-Volatile memory ensures the data does not loss even if power supply is accidentally removed

LCIFP8

Dual-Loop Card For additional loops



P-9945A

RS485 Class A Network Card



P-9935

RS232 card for PC connection



P-9965

CAN Class B Network Card



P-9935ModBus

ModBus Card for 3rd party interfacing



P-9965A

CAN Class A Network Card



P-9935TCP/IP

TCP/IP Network Card



P-9904

USB Printer Interface



P-9945RP

RS485 Repeater Card





GST-NRP00

Network Repeater Panel

Overview

GST-NRP00 Network Repeater Panel is based on GST network technology, providing remote control and indication of the fire alarm system.

Features

- Provide remote display and control of system
- Password protected access levels
- 8X18 characters LCD screen
- 15 LEDs to display important information
- Functional control of network panels
- Network-wide operation: Acknowledge, Silence, Reset
- Flush-mount or surface-mount structure
- Meet network protocol by selecting suitable network card

P-9940A

RS485 Class A Network Card



P-9960

CAN Class B Network Card



P-9960A

CAN Class A Network Card



GST852RP

LCD Repeater Panel

Overview

GST-852RP repeater panel is a remote indication unit of GST addressable system. In case of fire, the repeater panel will display the fire type, time and location details together with sound for local notification. This addressable repeater is possible to be connected with GST addressable panels through RS485 links.

Features

- Big size LCD display with backlight
- Compatible with all GST intelligent panels
- Mute and lamp test
- Electrically addressing

GST8903

Intelligent Graphic Repeater Panel

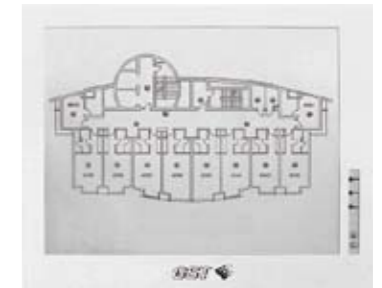

Overview

GST8903 graphic repeater panel (MIMIC panel) is a remote indication unit of GST addressable system. In case of fire or fault, the repeater panel will show the message by specified LED in certain position of the layout drawing, indicating the exact location clearly. This addressable repeater is possible to be connected with GST addressable panels through RS485 links.

Features

- Up to 100 LED indication points
- Local buzzer alarm and mute
- Custom Graphical layout to project requirement
- Programmable to display zones or individual device
- Programmable to indicate Fire, action and Fault conditions
- A3, A2, A1 and A0 sizes



DI-9101E

Intelligent Combination Heat Photoelectric Smoke Detector

The multi-sensor combines both smoke and heat detections to build fast and reliable performance. 2 smoke sensitivity levels can be set. Heat detection is based on both FT & RR.



DI-9102E

Intelligent Photoelectric Smoke Detector

The optical detector is designed based on light scattering technology with high performance chamber, suitable for detecting slow burning or smoldering fires. 2 sensitivity levels can be set.



DI-9103E

Intelligent Rate of Rise and Fixed Temperature Heat Detector

The dual heat detector can provide FT & RR fire alarm by analyzing the temperature status by semiconductor heat sensor. 3 detection classes can be set A1R, A2S & BS.

Overview

DI-91xxE series intelligent detectors adopt the latest digital loop protocol, compatible with GST intelligent fire alarm control panels. With digital communication, the detectors can raise fast alarm signal within 1 second, and much more control can be processed.

The detectors can be installed onto the common detector base DB-01. A remote indicator C-9314P can be connected to each detector.

Features

- Electrically addressed, can be modified by programmer
- Strong environmental adaptability due to drift compensation
- Self-diagnostic
- Reed switch test
- Fire LED allows 360° viewing
- LED indication for normal status can be turned off by handheld programmer

C-9314P

Remote Indicator



DB-01

Common Detector Base



I-9101

Intelligent Combination Heat Photoelectric Smoke Detector

The multi-sensor combines both smoke and heat detections to build fast and reliable performance. 3 smoke sensitivity levels can be set. Heat detection class is default at A2R, which the rate of rise detection can be switched off.



I-9102

Intelligent Photoelectric Smoke Detector

The optical detector is designed based on light scattering technology with high performance chamber, suitable for detecting slow burning or smoldering fires.



I-9103

Intelligent Rate of Rise and Fixed Temperature Heat Detector

The dual heat detector can provide FT & RR fire alarm by analyzing the temperature status by semiconductor heat sensor. Detection class is A1R.

Overview

I-91xx series intelligent detectors adopt the latest digital loop protocol, compatible with GST intelligent fire alarm control panels. With digital communication, the detectors can raise fast alarm signal within 1 second, and much more control can be processed.

The detectors can be installed onto the common detector base DZ-03.

For certain buildings do not have conceal conduit, a thick base DZ-03T can be used allowing cable entry from 4 directions.

A remote indicator C-9314P can be connected to each detector.

Features

- Electrically addressed, can be modified by programmer
- Strong environmental adaptability due to drift compensation
- Self-diagnostic
- Twin LED allows 360° viewing

C-9314P

Remote Indicator



DZ-03T

Thick Detector Base



I-9104

Intelligent Ultraviolet Flame Detector

Overview

I-9104 Intelligent Ultraviolet Flame Detector detects fire by analyzing ultraviolet radiation of flame. It's applicable to places where open fire, fire with intense flame radiation and fire without smoldering stage take place easily, as well as places where quick response to a fire is required. Used together with other detectors, it can alarm fire in time to minimize losses as much as possible. The detectors can be installed onto the common detector base DZ-03.



Features

- High sensitivity, reliable performance, dust-proof, damp-proof and corrosion-proof
- Three sensitivity levels
- Electronically addressed in field
- Built-in microprocessor stores 14 history data
- Self-diagnostic



I-9105R

Intelligent Reflective Beam Detector

Overview

I-9105R Intelligent Reflective Beam detector is addressable reflective infrared beam smoke detector that can be used as Addressable or Conventional. With excellent built-in microprocessor, the detector can carry out system adjustment, drift compensation of ambient data, and judgment of fire and fault through fixed algorithm. The sensitivity of the detector can be set through hand held programmer in field, to suit different application conditions. The detector is suitable to historical buildings, warehouses, large storages, shopping malls, leisure centers, exhibition halls, hotel lobbies, printing houses, clothing factories, museums and prisons. 4 reflector plates are provided in same package. Usually 1 piece is enough for distance less than 40 meters, and 4 pieces are prepared for long distance up to 100 meters

Features

- Wide operating voltage range, large monitoring areas
- Combination of the emitting and receiving part makes mounting easy and optical pathway accurate
- Built-in microprocessor enables intelligent judgment about fire alarm and fault
- The detector can calibrate easily, which ensures a single person complete adjustment in short time. It's also convenient to operate
- Self-diagnostic function can monitor the internal fault
- Drift compensation for factors changing, such as a certain of dust accumulation, positional excursion and ageing transmitter
- Electronically addressed by programmer
- Two sensitivity levels can be set in field
- Attractive and decent appearance

RP-9105

Reflector Plate



DI-9204E

Digital Manual Call Point

Overview

DI-9204E digital manual call point adopts the latest digital loop protocol, compatible with GST intelligent fire alarm control panels. The manual call point is semi-flush mount type. A back box is supplied for surface mounting.

Features

- Re-settable (non-breaking glass) via special key
- Dual activation indication
- Electronically addressed
- Friendly installation and test
- Wiring before termination



D-92WPB

Water Proof Box

Overview

D-92WPB Weather Proof Box is for application of manual call point outdoor installation to provide weather proofing. And the weather proof box is able to protect the manual call point from unwanted activation. Furthermore, it is also an effective guard against physical damage. Internal space is designed to suit most types of European style MCP.

Features

- IP65 cover offers fully protection of manual call point
- Meets the requirement of '2 step operation'
- Clear and durable PC cover
- Surface mounting enables the installation easily
- 60mm hole distance and enough internal space to suit most types of European style MCP
- Reserved place for additional micro-switch, battery, buzzer, etc



D-92FC

Flip Cover

Overview

The D-92FC protective flip cover is installed with D series manual call point, to build a double action of the MCP, prevent from accident trigger operation.

Features

- Material: PMMA
- Dimension: 87 X 92 X 20 (mm)
- Thickness: 1.7mm



I-9300

Addressable Single Input Module

The I-9300 input module is powered, for receiving normally-open or normally-closed contact signal. For normally-open signal, the input cable can be monitored with EOLR.



I-9319

Addressable Zone Monitor Module

The I-9319 monitor module is designed to connect conventional detectors into addressable system, powered by external 24VDC. Maximum 25 conventional detectors can be connected to in each zone.

It is also useful to monitor equipment status with both active and fault signals

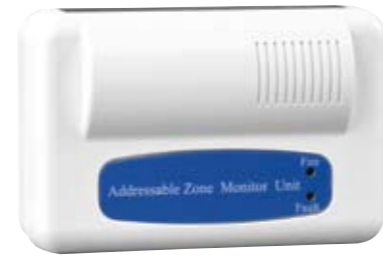

I-9301

Addressable Single Output Module

The I-9301 output module is suitable to drive conventional notification devices or other power required equipment in 4-wire mode by external 24VDC power supplying, and also possible to provide dry contact output in loop powered mode. Maximum 1A output current can be controlled in 4-wire mode.



Overview

I-93xx series modules adopt the latest digital loop protocol, compatible with GST intelligent fire alarm control panels, to interface with conventional or non-addressable equipment.

The working mode of input module can be changed by hand hold programmer. It is suitable for connecting Flow Switch, Zonal Valve, Fire Pump, and etc.

The zone monitor module has a wide range of active threshold, to suit most conventional detectors and manual call points. The working mode of output module can be changed by hand hold programmer. The dry contact output mode is suitable for controlling Elevator, Fire Door, etc or interfacing to 3rd party system. The power output is suitable to drive conventional notification devices.

The modules are surface mount type with bottom cable entry. A back box B-9310 should be used for surface cabling.

Features

- Electrically addressed, can be modified by programmer
- Self-diagnostic
- LEDs for fault and active indication
- Two part plug-in construction with base mounted termination allows easy installation and connection
- Intelligent interface can be addressed and plugged in to base at time of commissioning

B-9310

Back Box





I-9300S

Addressable Input Interface

Loop powered addressable input interface, designed to monitor dry contact signal.

Overview

Mini modules that can be fitted into back box, suitable for interfacing with non-addressable device.

Features

- Small size, suitable to be installed in back box
- Cable monitored for open circuit and short circuit
- The address and working mode can be modified in field through the programmer
- Built-in microprocessor processes messages intelligently



I-9303

Addressable Dual I/O Module

Overview

The I-9303 module occupies two addresses, each address can be controlled independently, energizes the relative relay and light the indicator. Each address corresponds to one input. After receiving feedback signal from controlled equipment, the module transmits feedback message to FACP.

Features

- Built-in microprocessor processes messages intelligently
- Providing two input channels, working mode can be set normally open and normally closed through handheld programmer
- Occupying two consecutive addresses, can be modified through a programmer
- Plug-in structure

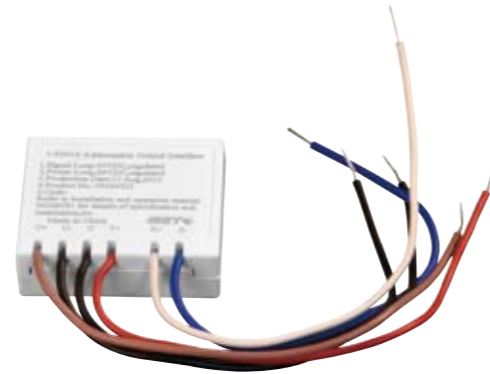

I-9301S

Addressable Output Interface

Provides 24VDC active output to drive fire-fighting or fire notification devices. External power supply is required.



DI-9309

Addressable Multi-Channel Interface

Overview

An integrated solution for application of multi-input signals, saving mounting space and installation cost. Each output channel occupies an individual address and receives start command from FACP, energizes the related relay, gives dry contact output. Each input is corresponded to one address to receive the state signal and transmit it to FACP. The quantity of channels can be set by jumpers.

Features

- Max. 16 channels of independent inputs. The quantity can be set as required
- Two channels of independent dry contact outputs
- 3-18 consecutive addresses, changing with selected channel quantity
- Power supply monitored
- Cable monitored for open circuit and short circuit

I-9305

Voice Alarm Zone Control Module

Overview

The I-9305 Voice Alarm Zone Control Module is designed to switch on off the voice alarm broadcasting. The module is possible to monitor the power supply, output circuit, report fault in case of abnormal condition.

Set as auto feedback mode, the module can transmit feedback signal automatically to the control panel after switching to fire alarm broadcasting.



Features

- Input signals: 75VDC, 100VDC VA signal or 24VDC power
- Connect input port (XF+, XF-) with output port (SP+, SP-) when receiving start signal from the control panel
- Electrically addressed, can be programmed on site by handheld programmer
- Loop-powered
- Output circuit monitored. Report fault message when the output circuit is short or broken
- Plug-in structure

I-9401

Addressable Sounder Strobe

Overview

I-9401 addressable sounder strobe can give audible and visual notification signal when activated by GST intelligent fire alarm control panel, to draw attention or evacuate in case of emergency.

Features

- Red Plexiglas lens, hi-light red, striking, long-life
- Electrically addressed, can be modified by programmer
- Sound level over 85dB
- Two part plug in structure for easy installation



I-9403

Intelligent Sounder Strobe

16 programmable tones with normal/low power consumption mode, powered by loop or external 24VDC source. Strobe provided by high intensity LED cluster



I-9404

Intelligent Sounder

16 programmable tones with normal/low power consumption mode, powered by loop or external 24VDC source.

Overview

I-9403 Intelligent Sounder Strobe and I-9404 Intelligent Sounder are addressable notification devices, can be controlled directly by loop command following preprogrammed equations. The sounder strobe provides pre-alarm/alarm sound together with flashing high-light LED, well the sounder provides sound only.

Features

- Electrically addressed, can be modified by programmer
- Two parts construction with base mounted termination allows easy installation
- 16 programmable alarm tones
- Optional Evacuate + Alert mode
- Optional loop powered or external 24VDC powering
- Optional power saving mode or normal mode

C-94DB

Deep Base

Use with I-9403 I-9404 I-9407
C-9403 C-9404 for Surface
Cable Entry



I-9402

Addressable Base Mount Sounder

Overview

I-9402 addressable base mount sounder takes place of standard detector base, to save space and installation cost, suitable for bedroom and meeting rooms.



Features

- Electrically addressed, can be modified by programmer
- Take place of standard detector base DZ-03
- 4 working mode to meet various requirements



I-9405

Addressable Sounder Base

16 programmable tones, powered by loop. Share 1 address with detector in 2-address mode, or individual control in single address mode

Overview

I-9405 Addressable Sounder Base and I-9406 Addressable Flashing Beacon Base are addressable notification devices, can be controlled directly by loop command following preprogrammed equations. The sounder bases are "sandwich" type, can be easily inserted between the standard base DZ-03 and detector.

Features

- Electrically addressed, can be modified by programmer
- Three programmable modes
- 16 selectable tones
- Sandwich structure for easy installation. No additional cable required



I-9406

Addressable Flashing Beacon Base

16 programmable tones, powered by loop. Share 1 address with detector in 2-address mode, or individual control in single-address / double-address mode
Flash light provided by high intensity LED



DI-9405

Addressable Sounder Base

16 programmable tones, powered by loop. Share 1 address with detector in 2-address mode, or individual control in single-address / double-address mode

Overview

DI-9405 Addressable Sounder Base and DI-9406 Addressable Flashing Beacon Base are addressable notification devices, can be controlled directly by loop command following preprogrammed equations. The sounder bases are "sandwich" type, can be easily inserted between the standard base DB-01 and detector.

Features

- Electrically addressed, can be modified by programmer
- Three programmable modes
- 16 selectable tones
- Sandwich structure for easy installation. No additional cable required



DI-9406

Addressable Flashing Beacon Base

16 programmable tones, powered by loop. Share 1 address with detector in 2-address mode, or individual control in single-address / double-address mode
Flash light provided by high intensity LED



C-9503E

Loop Isolator

Overview

C-9503E Loop Isolator is the protection facility for addressable loop, can isolate the shorted circuit from the complete loop to ensure normal operation of other parts and locate the isolated part. The isolator is applicable to all kinds of loop fire alarm systems, suitable for Class A and Class B.

Features

- Polarity-sensitive external connections. Input and output can be used inversely without direction
- Delayed power-up to output end devices, avoids strong transient current when the load is heavy
- Plug-in structure



DC-9504E

Base Mount Isolator

Isolator base to replace DB-01 common base, compatible with DI series detectors

Overview

The isolator base provides simple application method to save the installation space and cost.

Features

- Polarity-sensitive external connections. Input and output can be used inversely without direction
- Delayed power-up to output end devices, avoids strong transient current when the load is heavy



C-9504E

Base Mount Short Circuit Isolator

Isolator base to replace DZ-03 common base, compatible with I series detectors



GST-100

Intelligent Fire Alarm Control Panel

Overview

A minimized single loop addressable fire panel, designed in accordance with EN54-2 standard, to achieve simple installation, operation and maintenance, which make it ideal for smaller systems.

Features

- Maximum 8 detection zones, each with independent fire LED, fault/disable LED and zone label
- Class A loop, maximum capacity of 128 addressable devices
- 122x32 lattice LCD assisting the LED indicators to display important information
- Non-volatile memory ensuring system data not lost on shutdown of power
- 3 relay outputs available which are SOUNDER OUTPUT (R+ and R-), ALARM OUTPUT and FAULT OUTPUT

P-9943

RS485 Communication Card
For connecting repeater panel or network



CAN100H-4

CAN Hub

4 Routes



CAN100H-8

CAN Hub

8 Routes



CAN100H-12

CAN Hub

12 Routes



CAN100H-16

CAN Hub

16 Routes

Overview

In addressable system, GST intelligent panels can be linked by CAN network. Through CAN hub, the fire panel network can be connected in star topology.

Features

- Communication Distance: 3000 meters
- Nodes capacity of each branch: 112
- Total system capacity based on panel models
- Avoiding loop interference to affect the whole system due to isolation between trunk and branch, branch and branch



CAN100F

Fiber Optic Converter

Overview

CAN100F is used to convert CAN signal to Fiber-optic, possible to expand communication distance up to 25km.

Features

- Transmission distance extends Max. 25 km
- Preventing against electromagnetic interference



CAN100S

CAN Relay

Overview

The CAN100S is used to extend CAN network distance. And when the network nodes are over limit, the relay can expand system capacity.

Features

- Increase 3000 meters of network distance
- Expand network nodes capacity. Max. 112 nodes under each relay

P-9910B

Hand Held Programmer

Overview

In GST intelligent system, all addressable devices are electronically addressed. P-9910B Hand Held Programmer is the tool for programming. It can also be used to read the parameters and set the working mode of those devices.

Features

- Hand held unit, portable tool
- Convenience operation
- Quadruple digit alphanumeric LCD display
- Low-consumption hibernation and power saving function
- Low battery indication
- WEEE & RoHS Compliant



P-9903

Loop Relay Module

Overview

In fire alarm system, there is always requirement to expand loop distance. And when the loop runs through heavy interference area, the signal may need to be protected. The P-9903 loop relay module can provide such functions.

Features

- Enhance loop appearance of distance and reliability
- Increase 1000 meters of loop distance
- Maximum 2 pieces of relays can be connected in serial
- Opt-isolated output signal, resistant to industrial interference
- Output supports Class B loop connection only
- WEEE & RoHS Compliant



EN54 Conventional Products

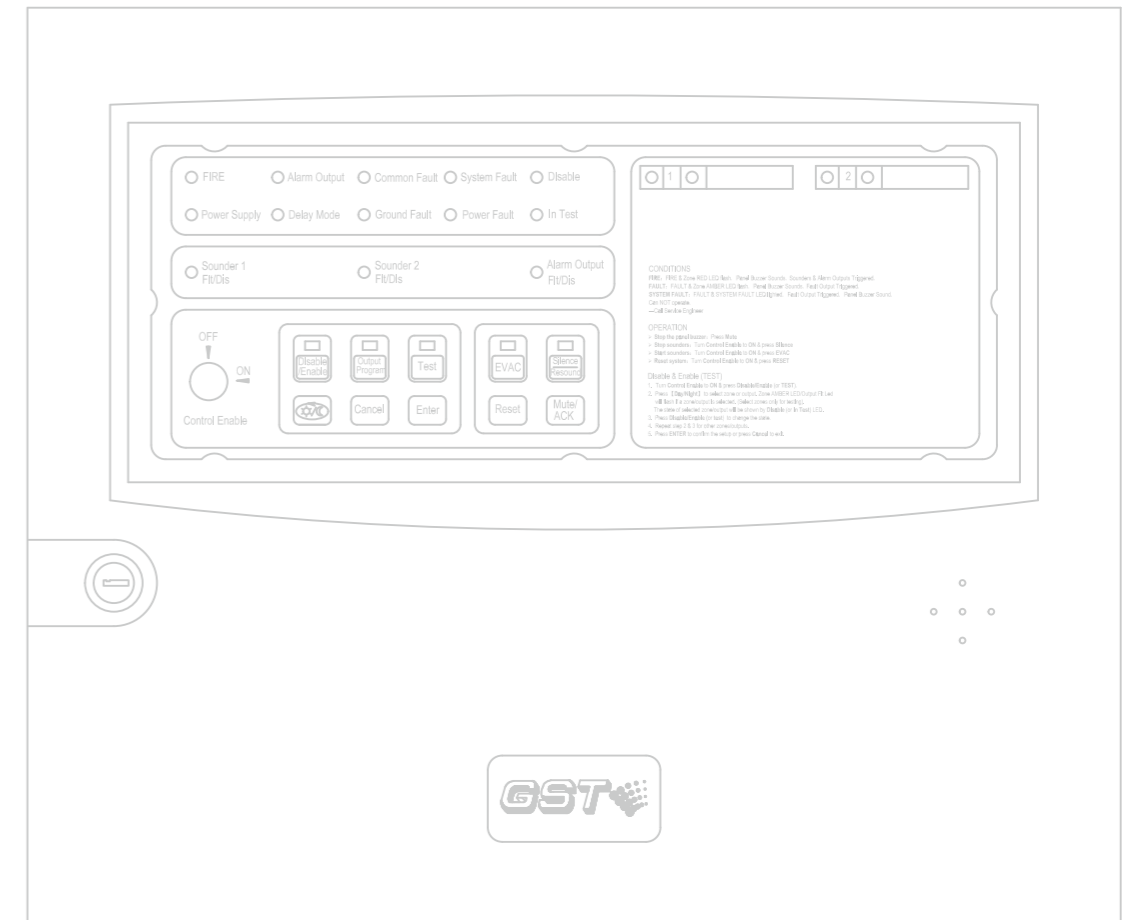



GST102A

GST104A

GST108A

GST116A

Conventional Fire Alarm Panel

Overview

The A series conventional fire panels provide 2/4/8/16 conventional fire detection zone connections, meet the requirement of simple fire alarm applications. The pleasing color and fascia design makes it suitable to be installed either at the main entrance or corridor. Beside the ordinary EOLR cable monitor method, the AEOL solution can keep cable continuity even with detector removed.

The panels carry forward the feature of simplified user operation of conventional systems, also provide advanced features like Day/Night mode, Output Program, Delay Output, Repeater Link, etc.

Specification

- Mains supply, 220/230VAC, 50/60Hz
- 2/4/8/16 zones. Each zone can have maximum 15 (AEOL) or 40 (EOLR) conventional detectors
- Compatible with GST conventional products
- Integrated charger and battery management program, fully comply with latest EN54-4 standard requirement
- Easy operation to enable/disable zones, sounder outputs and alarm output
- Output programmable for interlink between zones and sounder outputs, alert or evacuate tone, with or without delay
- Alarm output and Fault output are available for integrating into third party system
- Reserved repeater panel interface for fire alarm indication of multiple zones
- Dimension: 380mm x 320mm x 108mm

RB102A

Relay Board for GST102A

RB104A

Relay Board for GST104A

RB108A

Relay Board for GST108A

RB116A

Relay Board for GST116A

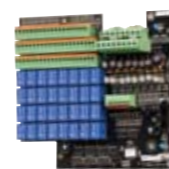

DP-9907

Active End of Line

Compatible with DC series conventional detectors



P-9907

Active End of Line

Compatible with C series conventional detectors



Overview

Instead of EOLR, with Active End of Line for conventional fire detection zones, it is possible to keep the connection continuity even if a detector is removed, and provide faulty indication at the same time, so that the downstream devices of the missing detector is still operational.

The AEOL is compatible with all GST conventional panel, and compatible with addressable zone interface I-9319.

A diode base is required for each detector instead of standard base, DZ-03D is suitable for C range detectors, DB-01D is suitable for DC range detector.

GST-RP16

Conventional Repeater Panel

Overview

The GST-RP16 repeater panel is compatible with GST102A/4A/8A/16A conventional panels. It is powered from FACP directly, providing Zonal Fire and general Fault indication

Specification

- Max. 16 zones
- Dimension: 280mm x 110mm x 46mm



GST-101

Conventional Fire Alarm Panel

Overview

1 zone conventional fire panel suits small and temporary applications.

Specification

- Mains supply, 220/230VAC, 50/60Hz
- Zone capacity 15 (AEOL) or 25 (EOLR) conventional detectors
- Compatible with GST conventional products
- Dimension: 210mm x 297mm x 90mm



DC-9101E

Conventional Combination Heat Photoelectric Smoke Detector

The multi-sensor combines both smoke and heat detections to build fast and reliable performance. 2 smoke sensitivity levels can be set. Heat detection is based on RR.



DC-9102E

Conventional Photoelectric Smoke Detector

The optical detector is designed based on light scattering technology with high performance chamber, suitable for detecting slow burning or smoldering fires. 2 sensitivity levels can be set.



DC-9103E

Conventional Rate of Rise and Fixed Temperature Heat Detector

The dual heat detector can provide FT & RR fire alarm by analyzing the temperature status by semiconductor heat sensor. 3 detection classes can be set A1R, A2S & BS.

Overview

DC-91xxE Conventional Detectors are new-generation products. With built-in microprocessor, the detectors are highly fixed with reliable fire judging program, which make it stable and reliable performance. With the new designed smoke chamber and intelligent program, the detectors have the ability of drift compensation and dust resistance. The detectors can be installed onto the common detector base DB-01. DB-01D will be suitable for connecting with Active End of Line Unit DP-9907. A remote indicator C-9314P can be connected to each detector.

Features

- Strong environmental adaptability due to drift compensation
- Self-diagnostic
- Reed switch test
- Fire LED allows 360° viewing



C-9314P

Remote Indicator



DB-01

Common Detector Base



DB-01D

Diode Detector Base

Co-operate with DP-9907, keep loop continuity even if a detector is removed.



DP-9907

Active End of Line

Co-operate with DB-01D, keep loop continuity even if a detector is removed.



C-9101

Conventional Combination Heat Photoelectric Smoke Detector

The multi-sensor combines both smoke and heat detections to build fast and reliable performance. Heat detection class is default at A1R.



C-9102

Conventional Photoelectric Smoke Detector

The optical detector is designed based on light scattering technology with high performance chamber, suitable for detecting slow burning or smoldering fires.



C-9103

Conventional Rate of Rise and Fixed Temperature Heat Detector

The dual heat detector can provide FT & RR fire alarm by analyzing the temperature status by semiconductor heat sensor. Detection class is A1R.

Overview

C-91xx detectors are conventional model, suitable to work with GST conventional panels, or I-9319 zone monitor module. With feature of drift compensation, the detectors are stable and reliable to meet most environments.

With the new designed smoke chamber and intelligent program, the detectors have the ability of drift compensation and dust resistance.

The detectors can be installed onto the common detector base DZ-03. DZ-03D will be suitable for connecting with Active End of Line Unit P-9907.

A remote indicator C-9314P can be connected to each detector.

Features

- Strong environmental adaptability due to drift compensation
- Self-diagnostic
- Twin LED allows 360° viewing



P-9907

Active End of Line

Co-operate with DZ-03D, keep loop continuity even a detector is removed.



DZ-03D

Diode Detector Base

Co-operate with P-9907, keep loop continuity even a detector is removed.



DZ-03

Common Detector Base



C-9314P

Remote Indicator

C-9104

Conventional Ultraviolet Flame Detector



Overview

C-9104 Conventional Ultraviolet Flame Detector detects fire by analyzing ultraviolet radiation of flame. It's applicable to places where open fire, fire with intense flame radiation and fire without smoldering stage take place easily, as well as places where quick response to a fire is required. Used together with other detectors, it can alarm fire in time to minimize losses as much as possible.

The detectors can be installed onto the common detector base DZ-03.

Features

- High sensitivity, reliable performance, dust-proof, damp-proof and corrosion-proof
- Self-diagnostic



DC-9204E

Innovation Manual Call Point

Overview

DC-9204E innovation manual call point is non-addressable. It alarms by pressing the glass. It can be simply connected to compatible conventional fire alarm system from various manufacturers. This MCP is suitable for public places. When there is fire, pressing the glass on this MCP can send alarm signal to compatible conventional fire alarm control panel.

Features

- Re-settable (non-breaking glass) via special key
- Dual activation indication
- Friendly installation and test
- Wiring before termination



GST-JL

Alarm Bell

Overview

The bell has a simple structure and red coated steel casing, with novel pattern and easy installation. It is applicable to the fire alarm equipment of factory, workshop, hotel as well as large and medium sized buildings, provides clear and continuous alarm sound.

Features

- 24VDC power, 23mA operation
- 6" bell, 95dB@3m

C-9401

Conventional Sounder Strobe

Overview

C-9401 conventional sounder strobe can give audile and visual notification signal when powered by 24VDC, to draw attention or evacuate in case of emergency.

Features

- Red Plexiglas lens, hi-light red, striking, long-life
- Sound level over 85dB
- Two part plug in structure for easy installation



C-9403

Conventional Sounder Strobe

2 selectable tones
Strobe provided by high intensity LED cluster

Overview

C-9403 Conventional Sounder Strobe and C-9404 Conventional Sounder are notification devices, provide audile/visual warning signals when 24VDC supplied.

Features

- Two parts construction with base mounted termination allows easy installation
- 2 selectable alarm tones



C-9404

Conventional Sounder

2 selectable tones

C-94DB

Deep Base

Use with I-9403
I-9404 I-9407
C-9403 C-9404
for Surface
Cable Entry



UL Listed Products

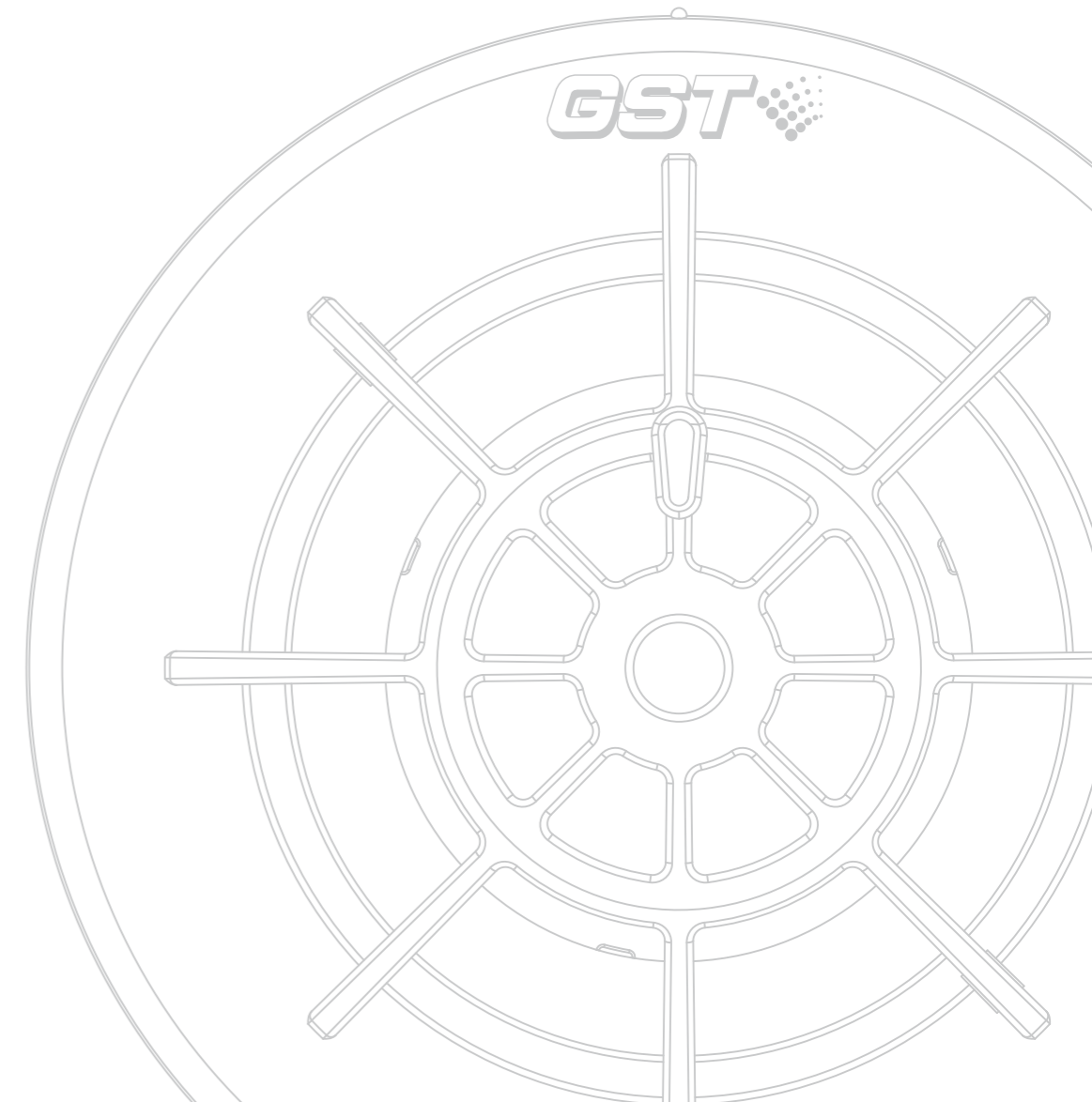



GST-M200

Intelligent Fire Alarm Control Panel

Single loop fire alarm control panel, adopts GST digital loop protocol to build intelligent fire alarm system. The wall-mounted FACP is suitable for small to medium project. The panel is possible to be powered by 100VAC to 230VAC, 50/60Hz.

Overview

GST-M200 is single loop intelligent fire alarm control panel. Class A loop can drive maximum 242 addresses. With LC200 loop card, the 2nd loop will expand system extra 242 addresses. The panel is programmable by keypad, or by PC through P-9930 communication card. To link with 3rd party system, the P-M9930Modbus card can provide data buffer for status of each device. P-M9960A CAN network card is used to build network of panels.

Features

- 2 Style Y Notification Appliance Circuits (NAC)
- 3 fixed relay outputs for fire/fault/supervisory
- Optional USB printer interface
- Optional graphic monitor station connection
- Walk Test function
- Positive Alarm Sequence (PAS) per point
- Advanced user friendly programming software including 'Fuzzy Logic'

LC200

Loop Card



P-9930

RS232 Communication Card

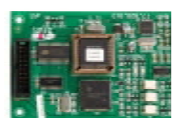

P-M9930Modbus

RS232 ModBus Communication Card



P-M9960A

CAN Network Card



DI-M9101

Intelligent Combination Heat Photoelectric Smoke Detector

The multi-sensor combines both smoke and heat detections to build fast and reliable performance. 2 smoke sensitivity levels can be set. Heat detection is based on both FT & RR.



DI-M9102

Intelligent Photoelectric Smoke Detector

The optical detector is designed based on light scattering technology with high performance chamber, suitable for detecting slow burning or smoldering fires.



DI-M9103

Intelligent Rate of Rise and Fixed Temperature Heat Detector

The dual heat detector can provide FT & RR fire alarm by analyzing the temperature status by semiconductor heat sensor. Rate of rise detection can be switched off for certain applications.

Overview

DI-M91xx series UL listed intelligent detectors adopt the latest digital loop protocol, compatible with GST UL listed intelligent fire alarm control panels. With digital communication, the detectors can raise fast alarm signal within 1 second, and much more control can be processed. The detectors can be installed onto the common detector base DB-M01. A remote indicator C-9314P can be connected to each detector.

Features

- Electrically addressed, can be modified by programmer
- Strong environmental adaptability due to drift compensation
- Self-diagnostic
- Reed switch test
- Fire LED allows 360° viewing
- LED indication for normal status can be turned off by handheld programmer

C-9314P

Remote Indicator (With BP-9314 Back Plate)



DB-M01

Common Detector Base





I-M9300

Addressable Single Input Module

The I-M9300 input module can be loop powered for receiving contact input, or connecting conventional detectors as a zone interface by powered with external 24VDC. Maximum 25 conventional detectors can be connected to in each zone.

Overview

DI-M93xx series UL listed modules adopt the latest digital loop protocol, compatible with GST UL listed intelligent fire alarm control panels, to interface with conventional or non-addressable equipment. The working mode of input module can be changed by hand hold programmer. It can be used as a simple input module or as a zone monitor module, suitable for connecting Flow Switch, Zonal Valve, Fire Pump, Conventional Detectors, and etc. The working mode of output module can be changed by hand hold programmer. The dry contact output mode is suitable for controlling Elevator, Fire Door, etc or interfacing to 3rd party system. The power output is suitable to drive conventional notification devices. The modules are surface mount type with bottom cable entry. A back box B-9310 should be used for surface cabling.

Features

- Electrically addressed, can be modified by programmer
- Self-diagnostic
- LEDs for fault and active indication
- Two part plug-in construction with base mounted termination allows easy installation and connection
- Intelligent interface can be addressed and plugged in to base at time of commissioning

B-9310

Back Box



I-M9301

Addressable Single Output Module

The I-M9301 output module is suitable to drive conventional notification devices or other power required equipment in 4-wire mode by external 24VDC power supplying, and it is also possible to provide dry contact output in loop powered mode. Maximum 1A output current can be controlled in 4-wire mode.



DI-M9204

Digital Manual Call Point

Overview

DI-M9204 digital manual call point adopts the latest digital loop protocol, compatible with GST UL listed intelligent fire alarm control panels. The manual call point is semi-flush mount type. A back box is supplied for surface mounting.

Features

- Re-settable (non-breaking glass) via special key
- Dual activation indication
- Electronically addressed
- Friendly installation and test
- Wiring before termination



C-M9503

Short Circuit Isolator

Module type isolator to be installed and terminated individually

Overview

Loop Isolator is the protection facility that can isolate the trouble part from the whole loop in case of short circuit occurs, to ensure the normal operation of other parts and locate the isolated part. The base mounted isolator is compatible with DI-M91xx detectors.

Features

- Isolates faulty part of the loop in the event of a short circuit
- Automatically reset once the fault has been cleared
- LED status indicator
- Support Class A and Class B loop connection
- Maximum 70 devices between each 2 isolators



DC-M9504

Base Mount Short Circuit Isolator

Base type isolator can be used as a detector base, or stand alone with a cover



DC-M9101

Conventional Combination Heat Photoelectric Smoke Detector

The multi-sensor combines both smoke and heat detections to build fast and reliable performance. 2 smoke sensitivity levels can be set. Heat detection is based on fixed temperature.



DC-M9102

Conventional Photoelectric Smoke Detector

The optical detector is designed based on light scattering technology with high performance chamber, suitable for detecting slow burning or smoldering fires.



DC-M9103

Conventional Rate of Rise and Fixed Temperature Heat Detector

The dual heat detector can provide FT & RR fire alarm by analyzing the temperature status by semiconductor heat sensor. Rate of rise detection can be switched off for certain applications.

Overview

DC-M91xx series UL listed conventional detectors are 2-wire type, alarm equivalent resistance 680Ω, possible to build fire alarm system together with UL listed conventional panels or addressable modules. The detectors can be installed onto the common detector base DB-M01. A remote indicator C-9314P can be connected to each detector.

Features

- Sensitivity levels can be modified by programmer
- Strong environmental adaptability due to drift compensation
- Self-diagnostic
- Reed switch test
- Fire LED allows 360° viewing
- LED indication for normal status can be turned off by handheld programmer

C-9314P

Remote Indicator
(With BP-9314 Back Plate)



DB-M01

Common Detector Base



DC-M9204

Innovation Manual Call Point

Overview

DC-M9204 conventional manual call point is compatible with UL listed conventional panels or addressable modules. The manual call point is semi-flush mount type. A back box is supplied for surface mounting.

Features

- Re-settable (non-breaking glass) via special key
- Dual activation indication
- Friendly installation and test
- Wiring before termination

P-9910B

Hand Held Programmer

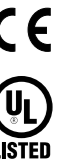

Overview

The P-9910B hand Held Programmer is the programming tool for all GST addressable devices and some of conventional devices. It is also the tool to set sensitivities, working modes and other parameters. The programmer has 2 terminal ports supplied with 2 types of cable links. The usual clamp link is for most devices. The I²C link (with a PS/2 plug) currently is only for GST8903 panel and I-9105R beam detector.

Features

- Hand held unit, portable tool
- Convenience operation
- Quadruple digit alphanumeric LCD display
- Low-consumption hibernation and power saving function
- Low battery indication

Gas Release Control Products

GST301

Conventional Gas Extinguishing Control Panel

Overview

The GST301 is standalone gas extinguishing control panel, provides 2 conventional detection zones to achieve double knock control, and an additional standard fire detection zone for other areas. The Duty and Standby Cylinder control can be automatic and manual controlled, with adjustable delay timer. The Built-in PSU and Charger can support 24 hours standby and 30 minutes activation period.



Specification

- Mains supply: 220/230VAC, 50/60Hz
- Backup Battery: 7AH/24VDC
- Sounder Output: 0.5A/24VDC
- Release Output: 2A/24VDC, Pulse
- Dimension: 300mm x 350mm x 110mm



GST303

Addressable Gas Extinguishing Control Panel

Overview

The GST303 and GST306 addressable gas extinguishing control panels are compatible with all GST intelligent fire alarm control panels, provide 3 or 6 protection zone outputs. The gas panel sits directly on addressable loop, achieving extinguishing control by carrying out the intelligent equations on the fire panel. External 24VDC power supply is required.



GST306

Addressable Gas Extinguishing Control Panel

Specification

- Mains supply: 24VDC
- Cylinder Output: Pulse (5s) or Continuous output, Max. 2A
- Release Indicator: 300mA/24VDC
- Sounder Output: Dry-contact, 1A/24VDC
- Dimension: 385mm x 444mm x 14mm
575mm x 444mm x 14mm

Gas Extinguishing
DO NOT ENTER

C-9317

Emergency Gas Override Control

C-9317 Emergency Gas Override Control is used to control the start and stop of gas extinguishing system, usually installed in areas to be protected.

The control button is compatible with GST301 conventional and GST303/306 addressable gas release control panels
Dimension: 144mm x 90mm x 58.5mm



C-9318

Gas Extinguishing Warning Indicator

C-9318 Gas Extinguishing Warning Indicator is the accessory of a gas extinguishing system, usually installed above the entrance of the protected area.

The warning indicator is compatible with GST301 conventional and GST303/306 addressable gas release control panels
Mains supply: 24VDC
Dimension: 348mm x 159mm x 29mm



C-9329

Gas Extinguishing Control Relay Module

C-9329 Gas Extinguishing Control Relay Module is to co-operate with GST303 or GST306 Gas Extinguishing Control Panel, to carry out gas release solenoid control and cable monitoring.

Dimension: 120mm x 80mm x 43mm



Emergency Telephone Products

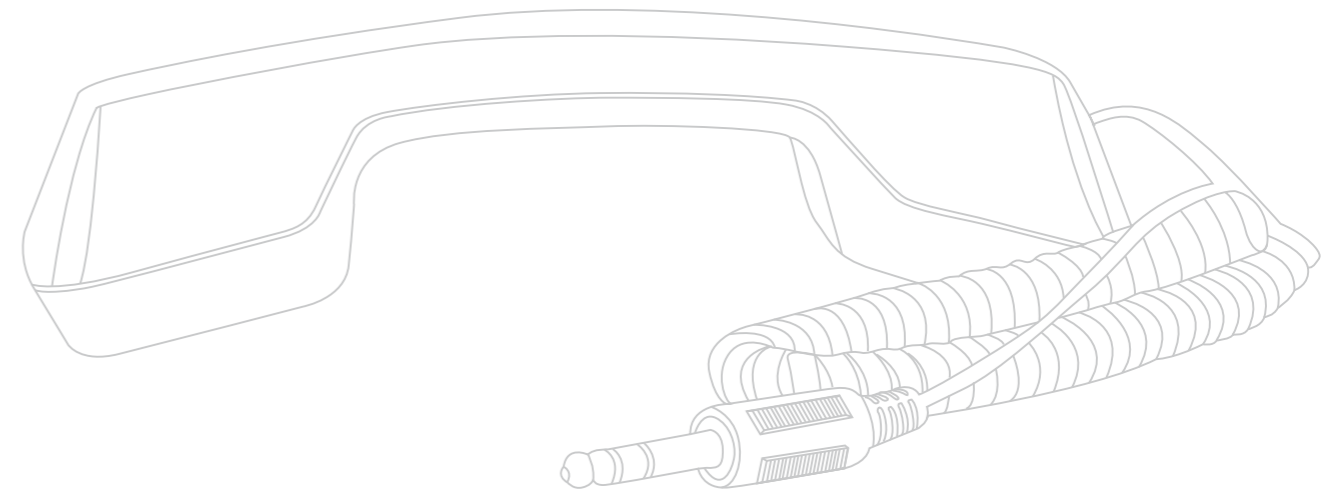

GST-FT8WN

Fire Telephone Panel

Overview

GST-FT8WN fire telephone panel is conventional model, specialized for emergency communication. The panel is networkable up to 8 panels. Call from handset will be transferred to networked fire telephone panels automatically after not answered by the dedicated panel. Each zone is fully monitored of cable fault. Failure of one zone will not effect on other zones.

Specification

- Mains supply: 24VDC
- Zone Capacity: 8
- Installation Method: Wall-mount
- Handset Capacity: 3 fixed handsets or 10 sockets
- Dimension: 400mm x 280mm x 100mm



GST-FT24N

Fire Telephone Panel

Overview

GST-FT24N fire telephone panel is conventional model, specialized for emergency communication. The panel is networkable up to 8 panels. Call from handset will be transferred to networked fire telephone panels automatically after not answered by the dedicated panel. Each zone is fully monitored of cable fault. Failure of one zone will not effect on other zones.

Specification

- Mains supply: 24VDC
- Zone Capacity: 24
- Installation Method: 19" Rack-mount
- Handset Capacity: 3 fixed handsets or 10 sockets
- Dimension: 482.5mm x 132.5mm x 225mm



P-9911(H)

Handsfree Speaker Fire Telephone

The P-9911(H) handset is wall mounted, compatible with GST-FT series of fire telephone panels, for emergency communication over a dedicated hard wired system normally located with the fire command centre. Dimension: 160mm x 80mm x 35mm



P-9911(F)

Fixed Fire Telephone Handset

The fixed handset is wall mounted, compatible with GST-FT series of fire telephone panels. The unit should be mounted in a suitable and dry location at about 1.5m from finished floor level. Dimension: 234mm x 146mm x 60mm



P-9911(M)

Mobile Fire Telephone Handset

P-9911(M) is a mobile type emergency telephone handset, which can be taken by the security guard, fireman or others on duty. The person can go to the nearest jack sockets, plug and talk to the central GST-FT series of fire telephone panels located in the command center. Usually 2-5 handsets are recommended according to amount of telephone sockets.



P-9911(J)

Fire Telephone Jack

P-9911(J) telephone socket normally locates at the landing levels of all core stairwells and escape routes. The person on site with a mobile handset may just plug & talk to the control center. The unit should be mounted in a suitable and dry location at about 1.5m from finished floor level. Dimension: 85mm x 85mm x 12mm



Explosion Proof Products

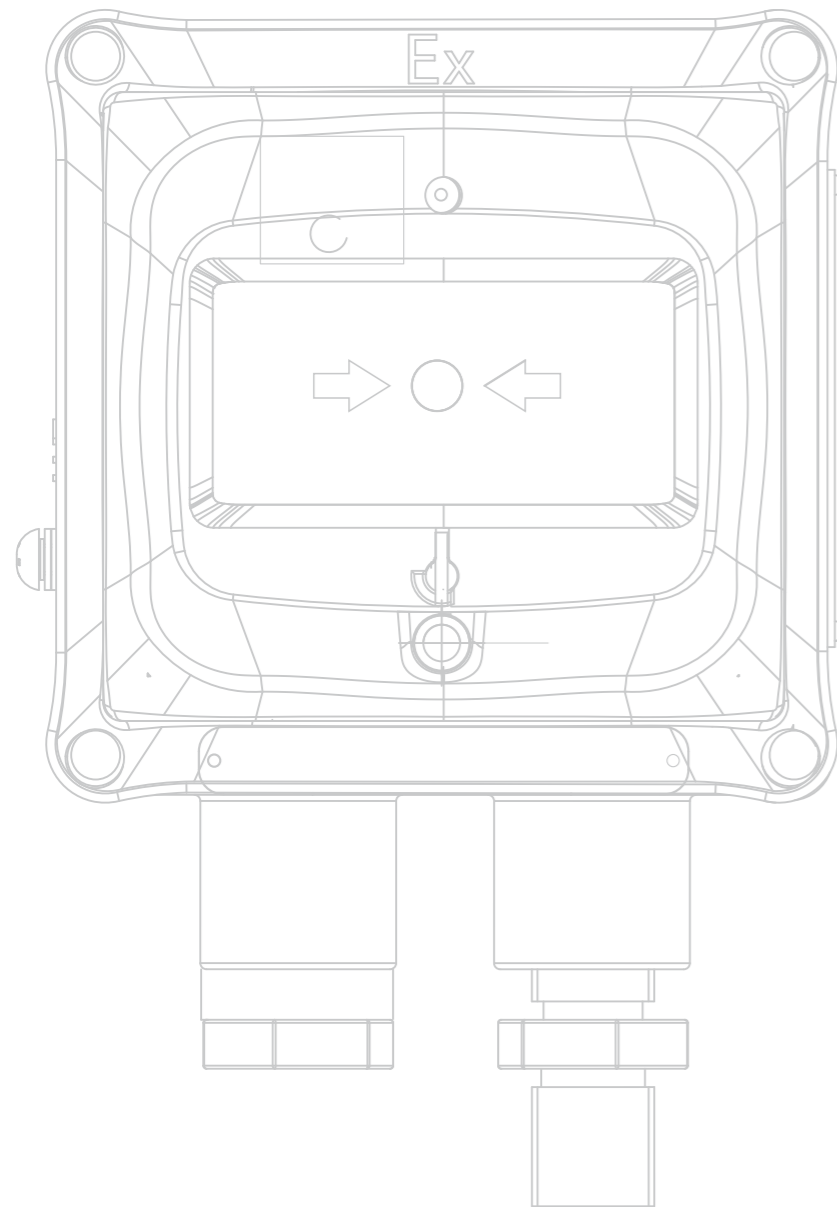

DI-9204Exd

Digital Flame-proof Manual Call Point



Overview

DI-9204Exd MCP is applicable to vessels, Zone 1 and 2 of explosive gas atmosphere and Zone 20, 21, and 22 of explosive dust atmosphere. It is also suitable for outdoor application.

The MCP can work at addressable mode to connect with GST's addressable FACP, or work at non-addressable mode to connect with 24VDC power and output dry-contact alarm signal.

Specification

- Operating Voltage: 24V
- Ingress Protection: IP65
- Material: ZL102 aluminum alloy, red
- Dimension: 219mm x 129mm x 95mm
- Ex Mark: ExdIIBT6 Gb / ExtbIIICT85°C Db
- Ex Certificate: CE12.1341
- ATEX Certificate: PRESAFE 14 ATEX 5549X

D-9105RExd

Digital Flame Proof Reflective Beam Detector



Overview

D-9105RExd Beam Detector is applicable to either commercial areas or hazardous industrial areas, such as Zone 1 and 2 of explosive gas areas and Zone 21 and 22 of combustible dust areas.

The detector is able to be used as addressable mode connecting in GST fire alarm loop, or non-addressable mode providing dry contact outputs for fire and fault conditions.

Specification

- Operating Voltage: 24V
- Ingress Protection: IP66
- Material: Stainless steel, metallic gray
- Dimension: 344mm x 240mm x 212mm
- Ex Mark: Exd IICT6 Gb / DIP A21 TA, T6
- Ex Certificate: CE11.1246X



DI-9104Exd

Digital Flame Proof UV Flame Detector

Overview

DI-9104Exd detects fire by picking up the ultraviolet light from flaming material. It's designed for areas where an open fire is liable to occur with large amount of radiation and no smoldering stage. This detector can be applicable to zone 1 and 2 of explosive areas. The detector is able to work either in addressable mode connecting with GST intelligent fire alarm control panel, or in non-addressable mode to transmit signal by outputting different resistance values.

Specification

- Operating Voltage: 24V
- Ingress Protection: IP66
- Material: ZL102 aluminum alloy, silvery grey
- Dimension: 147mm x 106mm x 92mm
- Ex Mark: ExdIICT6Gb
- Ex Certificate: CE12.1356X
- ATEX Certificate: PRESAFE 14 ATEX 5547



D-9107RExd

Digital Flame Proof Dual IR Flame Detector

Overview

The detector uses two pyroelectric infrared sensors to detect the change of light signal of flame and background light signal at two bands of infrared spectrum through individual processing channels. The detector is applicable to explosive Zone 1 and 2, and Zone 21 or 22 with flammable dust. The detector is able to be used as addressable mode connecting in GST fire alarm loop, or non-addressable mode providing dry contact outputs for fire and fault conditions.

Specification

- Operating Voltage: 24V
- Ingress Protection: IP66
- Material: Stainless steel, metallic gray
- Dimension: 166mm x 235mm x 199mm
- Ex Mark: Exd IICT6 Gb / ExtbIIICT85°C Db
- Ex Certificate: CE11.1246X
- ATEX Certificate: PRESAFE 14 ATEX 5548X



DC-9101(IS)

Intrinsicly Safe Combination Heat Photoelectric Smoke Detector

Ex Mark: Exib II CT6 Gb
Ex Certificate: CE11.2056
3 smoke sensitivity levels can be set.
FT and RR can be set

Overview

The Intrinsicly Safe Conventional Detectors are applicable to Zone 1 and Zone 2 of areas with explosion-proof requirement in petroleum and chemical industries. With explosion proof interface I-9332, the detectors can be connected into GST addressable system. Max.10 pieces (mixed) can be linked to each interface. A common base DB-01(IS) is available for the detectors.

DB-01(IS)

Intrinsicly Detector Base



DC-9102(IS)

Intrinsicly Safe Photoelectric Smoke Detector

Ex Mark: Exib II CT6 Gb
Ex Certificate: CE11.2130



DC-9103(IS)

Intrinsicly Safe Rate of Rise and Fixed Temperature Heat Detector

Ex Mark: Exib II CT6 Gb
Ex Certificate: CE11.2146





DC-9202(IS)

Intrinsically Safe Manual Call Point

Ex Mark: Exib II CT6 Gb
Ex Certificate: CE11.2142

Overview

The DC-9202(IS) Intrinsically Safe Conventional MCP is applicable to Zone 1 and Zone 2 of areas with explosion-proof requirement in petroleum and chemical industries. With explosion proof interface I-9330, the detectors can be connected into GST addressable system.



DC-9403(IS)

Intrinsically Safe Conventional Sounder Strobe

Ex Mark: Exib II CT6 Gb
Ex Certificate: CE11.2146

Overview

The Intrinsically Safe Conventional Sounder/Strobe are applicable to Zone 1 and Zone 2 of areas with explosion-proof requirement in petroleum and chemical industries. With explosion proof interface I-9333, the detectors can be connected into GST addressable system. Each interface can only drive 1 sounder/strobe.



DC-9404(IS)

Intrinsically Safe Conventional Sounder

Ex Mark: Exib II CT6 Gb
Ex Certificate: CE11.2145



I-9332

Intrinsically Safe Interface

Overview

The I-9332 interface is to connecting conventional intrinsically safe detectors and MCP into GST addressable fire alarm system. Any of the following detectors and call points alarms will be reported to the panel shown as an address. The built-in Zener Barrier provides energy limitation to the hazard area.



I-9333

Intrinsically Safe Interface

Overview

The I-9333 interface is to connecting conventional intrinsically safe sounders into GST addressable fire alarm system. Any of the following detectors and call points alarms will be reported to the panel shown as an address. The built-in Zener Barrier provides energy limitation to the hazard area.



GST-AS-200

Zener Safety Barrier

Overview

GST-AS-200 and GST-AS-300 Zener Safety Barriers are used to associate with intrinsically safe products. It provides protection by limiting the energy into explosive environment. It ensures the energy output always be controlled under a safe value in case of any kind of fault condition.

The 2 lines of GST-AS-300 are both fused, as of GST-AS-200 has only 1-line fused.

Max. Output Voltage: $U_o=28V$

Max. Output Current: $I_o=93mA$

GST-AS-300

Zener Safety Barrier

Gas Detector

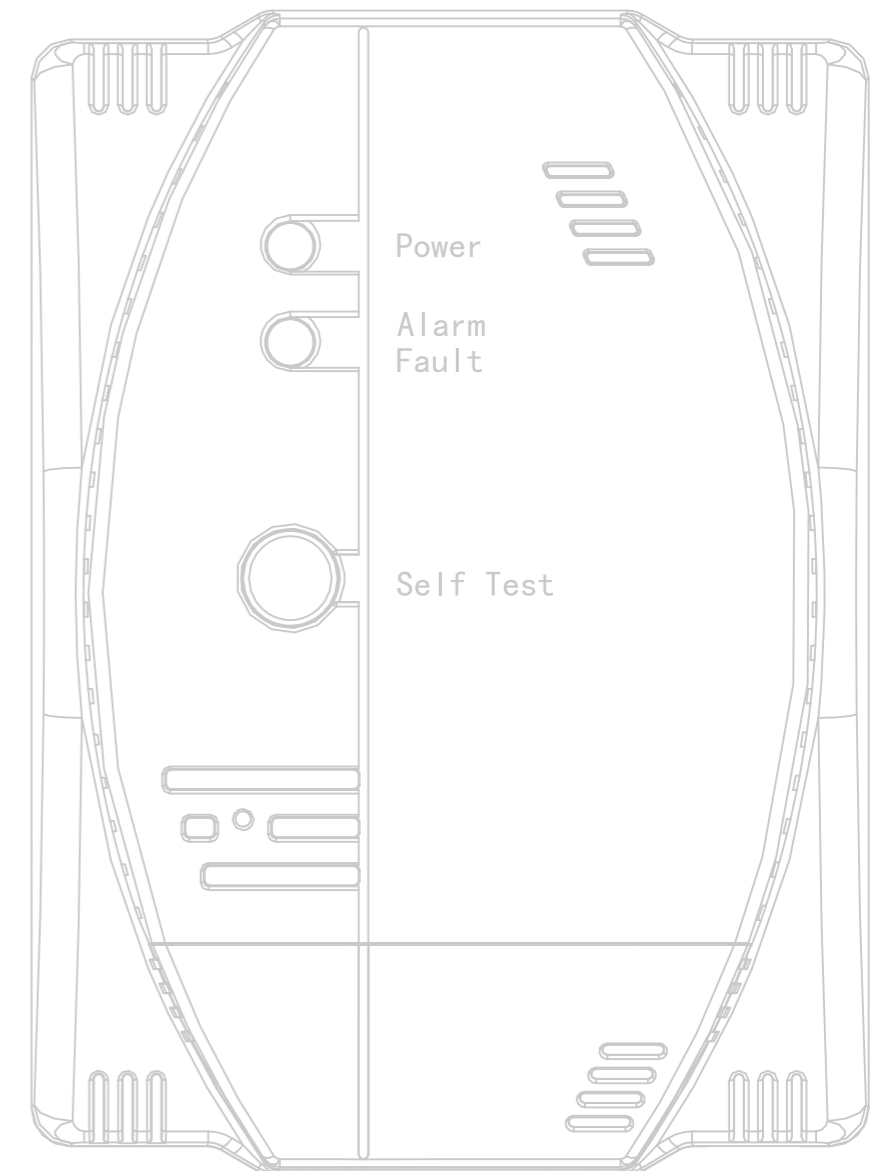

I-9602LW-CG
I-9602LW-LPG
I-9602LW-NG

Addressable Gas Detector
Coal Gas
Liquefied Petroleum Gas
Natural Gas

Overview

I-9602LW Addressable Gas Detector is used to detect leakage of home use combustible gas (LPG, Natural Gas or Coal Gas) in such areas as houses, hotels and apartments. When leakage is detected, the detector will generate high buzzer alert sound, and provide a dry contact to turn exhaust fan, a 12VDC source to switch off the gas valve. The addressable detector can be linked into GST fire alarm system to carry out intelligent control.

Specification

- Operating Voltage: 24VDC
- Alarm Threshold: CG: 400×10^{-6} (1%LEL)
LPG: 2000×10^{-6} (10%LEL)
NG: 3000×10^{-6} (6%LEL)
- Ingress Protection: IP30

C-9602LW-CG
C-9602LW-LPG
C-9602LW-NG

Conventional Gas Detector
Coal Gas
Liquefied Petroleum Gas
Natural Gas

Overview

I-9602LW Addressable Gas Detector is used to detect leakage of home use combustible gas (LPG, Natural Gas or Coal Gas) in such areas as houses, hotels and apartments. When leakage is detected, the detector will generate high buzzer alert sound, and provide a dry contact to turn exhaust fan, a 12VDC source to switch off the gas valve.

Specification

- Operating Voltage: 220VAC 50/60Hz
- Alarm Threshold: CG: 400×10^{-6} (1%LEL)
LPG: 2000×10^{-6} (10%LEL)
NG: 3000×10^{-6} (6%LEL)
- Ingress Protection: IP30



Power Supply Unit

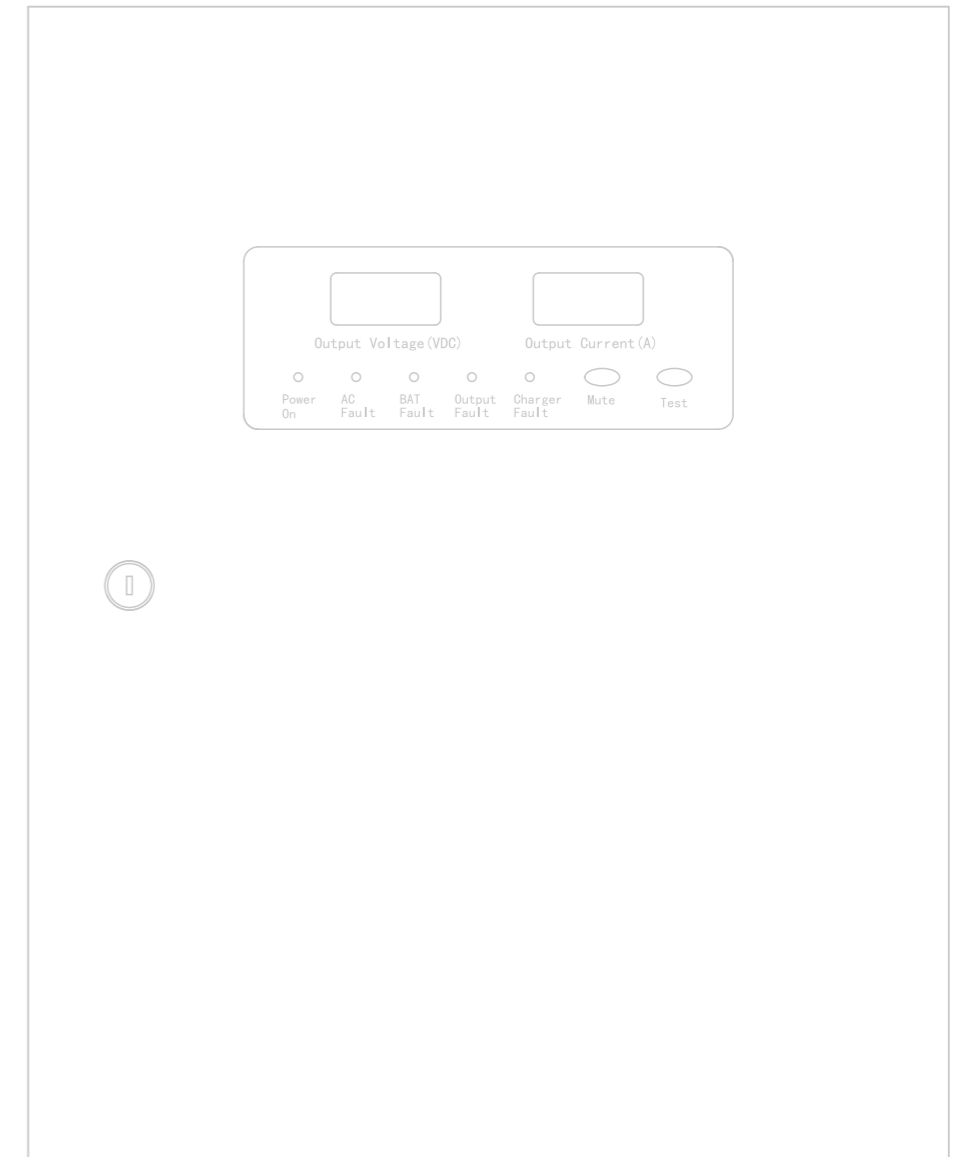

PSU24-5 PSU24-5A

Intelligent Power Supply Unit

Overview

The PSU24-5/5A power supply unit is to support heavy consumption application, part of the fire alarm devices require for external 24VDC power supply. The supply source is 230 VAC, 50/60 Hz. Nominal output load is 5A/24VDC. The built-in charger and maintenance-free sealed lead acid batteries ensure the standby supply. PSU24-5A is also possible to be connected into fire alarm loop, so that to report fault of mains loose, battery loose or output broken to the fire panel.

Specification

- Mains Supply: 230VAC+10%/-15%, 50/60Hz
- Rated Output: 5A/26.5V DC
- Backup Battery: 12Ah/24VDC
- Dimension: 400mm×318mm×128mm



PSU24-10 PSU24-10A

Intelligent Power Supply Unit

Overview

The PSU24-10/10A power supply unit is to support heavy consumption application, part of the fire alarm devices require for external 24VDC power supply. The supply source is 110-230 VAC, 50/60 Hz. Nominal output load is 10A/24VDC. The built-in charger and maintenance-free sealed lead acid batteries ensure the standby supply. PSU24-10A is also possible to be connected into fire alarm loop, so that to report fault of mains loose, battery loose or output broken to the fire panel.

Specification

- Mains Supply: 110VAC ~ 230VAC, 50/60Hz
- Rated Output: 10A/26.5V DC
- Backup Battery: 24Ah/24VDC
- Dimension: 520mm×350mm×156mm



Specified Detector

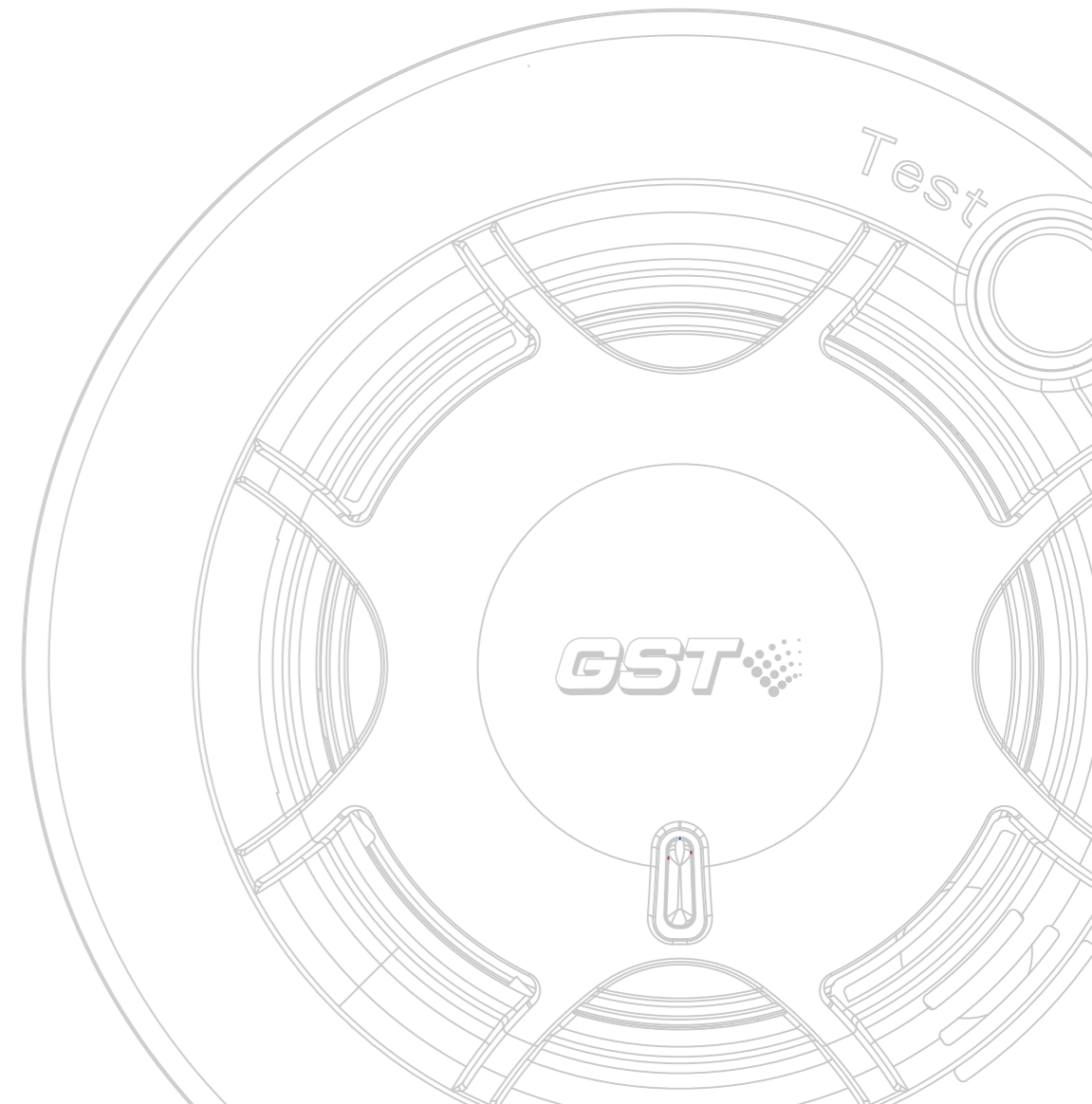

Value Added Unit



R6601

Conventional Smoke Detector

R6602

Conventional Heat Detector

Overview

The 4-wire type detectors are usually applied to security system, or standalone with relay output. Detector provides a normally-open contact, which will be closed when detector alarms.

Specification

- Operating Voltage: 12VDC (9.6VDC ~ 14.4VDC)
- Output Relay: 30VDC/1A
- Cabling Method: 4-wire, 2 for power, 2 for output
- Ingress Protection: IP23



S-9102R

S-9102N

Stand Alone Smoke Detector

Overview

Battery powered stand alone smoke detector, adapting optical chamber, to detect smoke produced by fire, gives high volume sound notification in case of alarm. It is suitable for small projects like home application, small shop, pub, and etc. The S-9102R provides a polarized N/O contact output (photoelectrical isolated) for further application. The S-9102N provides network function, suitable for group usage of the detector. All networked detectors will sound together when anyone of them alarms.

Specification

- Operating Voltage: 2-piece of AA LR6 alkaline batteries
- Battery Life: 3 years
- Detection Area: 60-100m²
- Alarm Sound: 80dB@3m

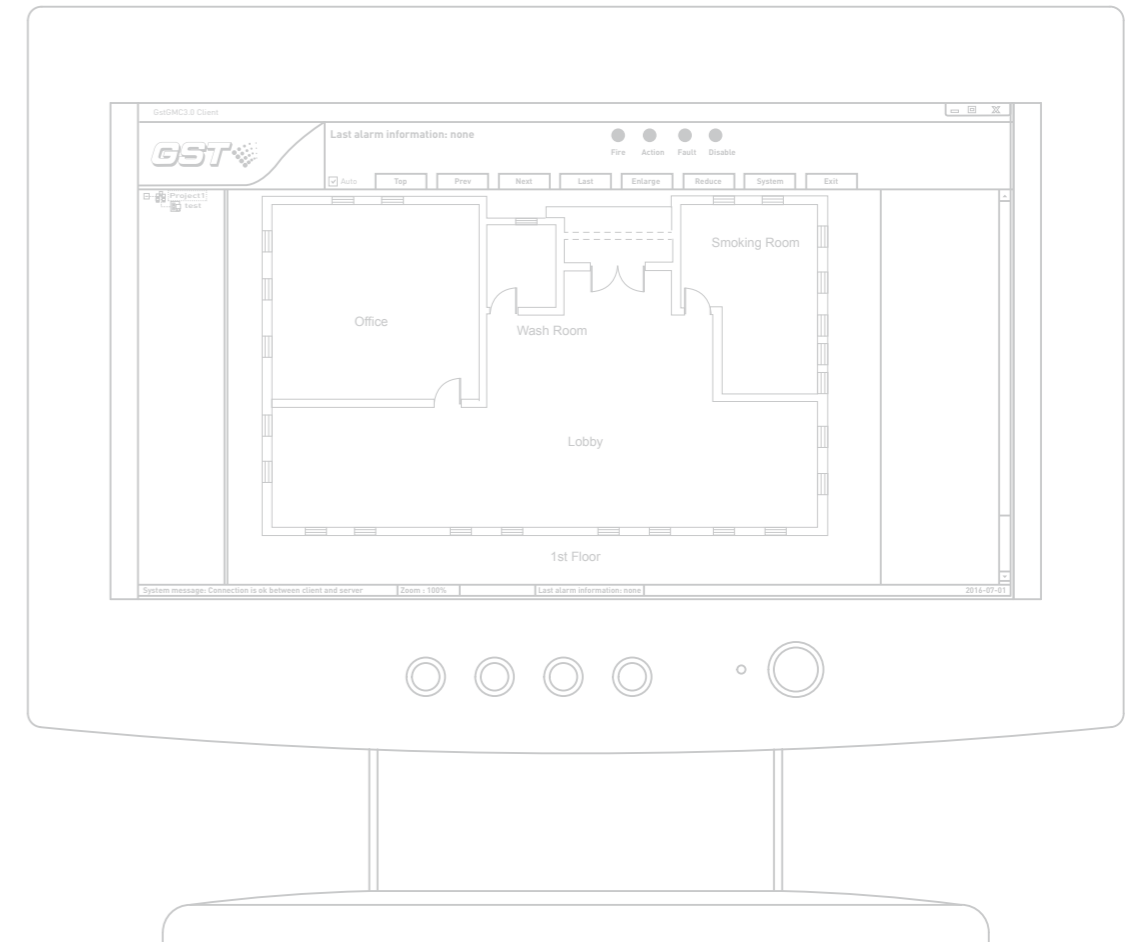



GST-GMC

Graphic Monitor Center

Overview

GstGMC3.0 Graphic Monitor Centre is a fire alarm system monitoring software. With friendly interface, the software may support 8 remote client stations plus local monitor station, making complete monitoring and control. Also with OLE for Process Control (OPC), the communication with fire alarm control panel can also be integrated into other systems. The related FACP includes GST200, GST200-2, GST200N, GST5000 and GST-IFP8.

Hardware Requirement

CPU: Pentium IV 1.7G or above
Minimum free Hard disk: 10GB
Memory: 512M or above

Operation System

Windows XP Professional (IE6.0 or above)
Windows 7

GST-DEF-KEY

USB Dongle



Overview

A sort of CPU or smart card based security device, to protect definition database of GST-DEF software. Unauthorized person without the dongle key is not possible to start the software.

System Diagram

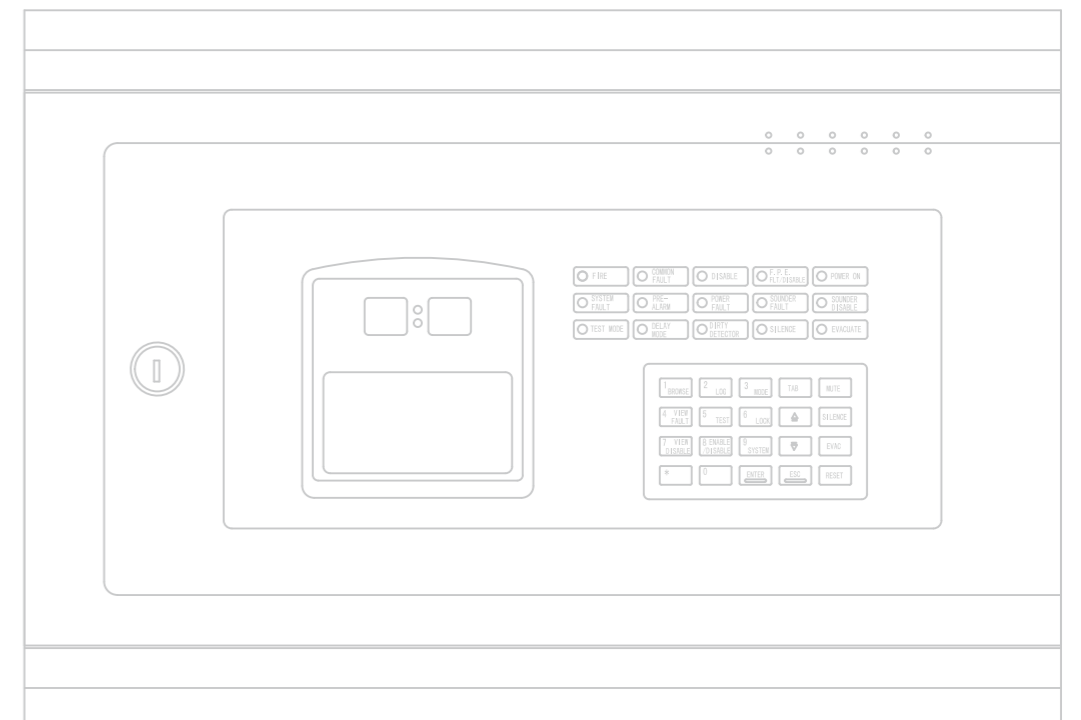

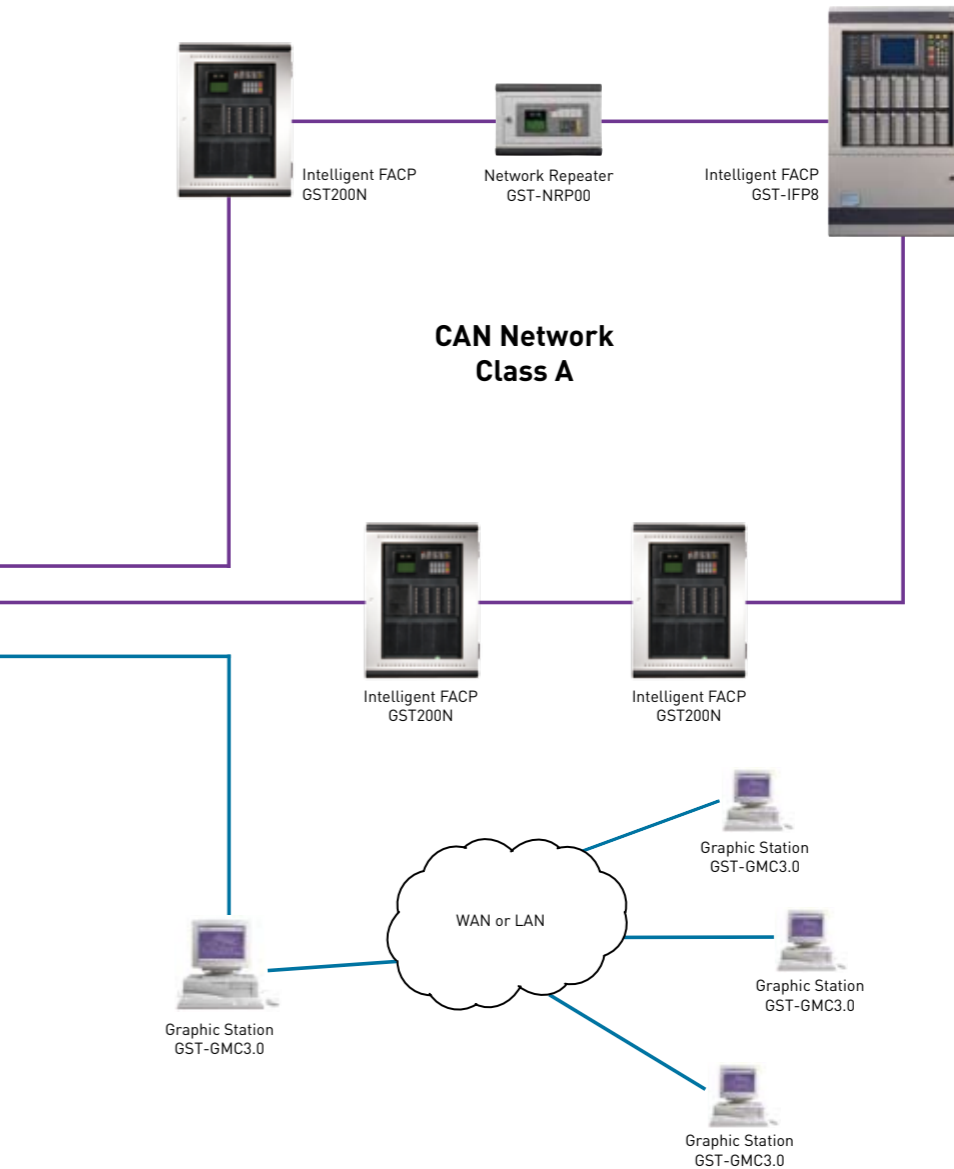
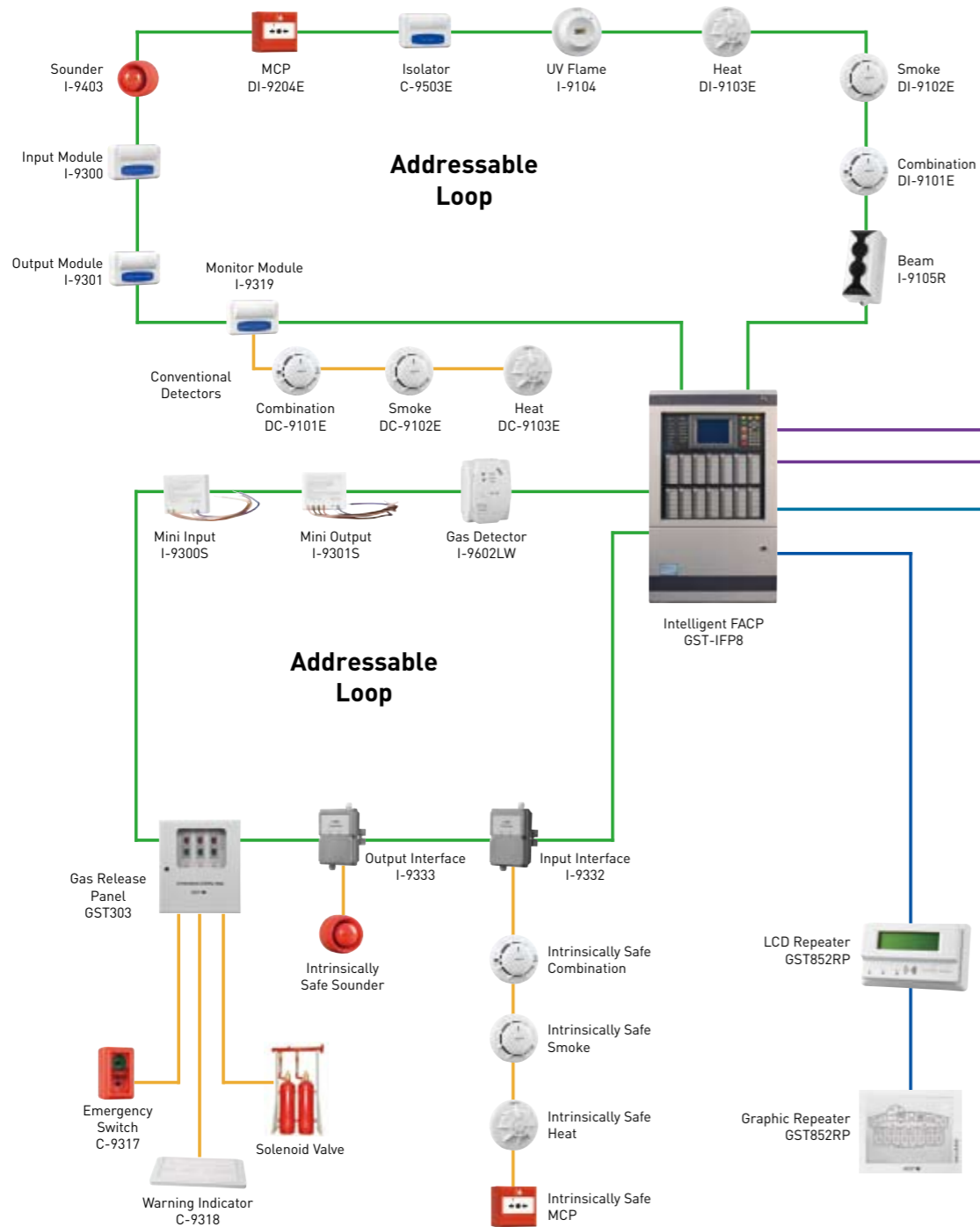

- CAN Network is possible to be Class A , Class B or Star Topology. Suitable network cards and accessories are available.
- External 24VDC Power Supply may be required by some devices.
- Max. 8 Remote Users can be connected to the host PC through WAN or LAN